

# DALGIÇ RAPTİYE®



Steel Bucket  
Fastener



Belt Lacing



Hinged  
Fastener



U-J Bolt



Oval Jackson  
Fastener



Bucket  
Fastener



Belt  
Fastener



Stretching  
Bolt

A trademark of

**DALGIÇ GLOBAL™**

**Head Office:** Orhanlı Mah. Demokrasi Cad. Işıkdag Plaza  
No:26/10 Tuzla - İstanbul Tel: + 90 216 394 36 36 / +90 216 561 34 37

**Ankara Branch:** Ostim OSB. Mah. 100. Yıl Bulvarı  
Prestij Plaza D Blok No:55/12 Yenimahalle - Ankara Tel: + 90 312 552 29 29

🌐 [dalgicraptiye.com](http://dalgicraptiye.com)

✉ [info@dalgicraptiye.com](mailto:info@dalgicraptiye.com)

📱 [f](https://www.facebook.com/dalgicraptiye) [@](https://www.instagram.com/dalgicraptiye) [y](https://www.youtube.com/dalgicraptiye) [in](https://www.linkedin.com/dalgicraptiye) /dalgicraptiye

# DALGIÇ<sup>®</sup> RAPTIYE

For more than 15 years Dalgıç Raptiye has been serving in a line that instils quality and trust with industrial connection equipment used in conveyor, crushing, screening, and crusher machine systems by improving and expanding its quality and product variety with each passing year.

Within its products, produced based on superior quality and continuity of quality, a perfect service understanding principle, which has high precision standards such as clip, Hinged Fastener, Bucket Fastener, Belt Lacing, Oval Jackson Fastener, U-J Bolt, Belt Fastener, Stretching Bolt, Dalgıç Raptiye provides solutions, in accordance to the customers' demands with a constant and honest service of understanding and satisfaction as principles before and after-sales.

Our brand which serves as the leader of the market in industries such as aggregate production, conveyor band systems which are situated in sectors such as mine and mill, mining jaw crushers, crushing and screening, provides product stock and supply. It continues its activities with the principles of meeting every need of customers, including customers in the dynamics by keeping them at the centre during the process and creating a stable and trust-based profile.



## FASTENER PRODUCT GROUP

|          |         |                     |
|----------|---------|---------------------|
| DRP-001  | 250 PCS | 1,5" Belt Fastener  |
| DRP-002  | 250 PCS | 2" Belt Fastener    |
| DRP-003  | 100 PCS | 2,5" Belt Fastener  |
| DK50*50  | 5 SET   | Hinged Fastener Set |
| DK50*60  | 5 SET   | Hinged Fastener Set |
| DK50*65  | 5 SET   | Hinged Fastener Set |
| DK50*80  | 5 SET   | Hinged Fastener Set |
| DK50*100 | 5 SET   | Hinged Fastener Set |
| DK50*120 | 5 SET   | Hinged Fastener Set |



## ASSEMBLY WRENCH PRODUCT GROUP

|         |                                    |
|---------|------------------------------------|
| DMA-033 | 1,5" Belt Fastener Wrench          |
| DMA-034 | 2" Belt Fastener Wrench            |
| DMA-035 | 1,5-2" Belt Fastener Power Wrench  |
| DMA-036 | 2,5" Belt Fastener Power Wrench    |
| DMA-037 | 1,5-2" Belt Fastener Mounting Clip |
| DMA-038 | Belt Punch                         |



## BELT LACING PRODUCT GROUP

|         |       |                     |
|---------|-------|---------------------|
| DSK-004 | 5 SET | 01 Belt Lacing      |
| DSK-005 | 5 SET | 07 Belt Lacing      |
| DSK-006 | 5 SET | 15 Belt Lacing      |
| DSK-007 | 5 SET | 27 x 30 Belt Lacing |
|         | 5 SET | 27 x 60 Belt Lacing |
|         | 5 SET | 27 x 80 Belt Lacing |
| DSK-008 | 5 SET | 35 x 30 Belt Lacing |
|         | 5 SET | 35 x 60 Belt Lacing |
|         | 5 SET | 35 x 80 Belt Lacing |
| DSK-009 | 5 SET | 45 x 30 Belt Lacing |
|         | 5 SET | 45 x 60 Belt Lacing |
|         | 5 SET | 45 x 80 Belt Lacing |





## SIEVE ASSEMBLY EQUIPMENT U - BOLT

|         |         |               |
|---------|---------|---------------|
| DME-025 | 250 PCS | M5 - 8,5 cm*  |
|         | 250 PCS | M6 - 8,5 cm*  |
|         | 200 PCS | M8 - 8,5 cm*  |
|         | 150 PCS | M10 - 8,5 cm* |
|         | 100 PCS | M12 - 8,5 cm* |

|         |         |                |
|---------|---------|----------------|
| DME-026 | 250 PCS | M5 - 11,5 cm*  |
|         | 250 PCS | M6 - 11,5 cm*  |
|         | 150 PCS | M8 - 11,5 cm*  |
|         | 100 PCS | M10 - 11,5 cm* |
|         | 100 PCS | M12 - 11,5 cm* |

|         |         |                              |
|---------|---------|------------------------------|
| DME-027 | 100 PCS | M6 - 14,5 cm* (Custom Size)  |
|         | 100 PCS | M8 - 14,5 cm* (Custom Size)  |
|         | 100 PCS | M10 - 14,5 cm* (Custom Size) |
|         | 100 PCS | M12 - 14,5 cm* (Custom Size) |

\*Production is made according to the requested dimensions.

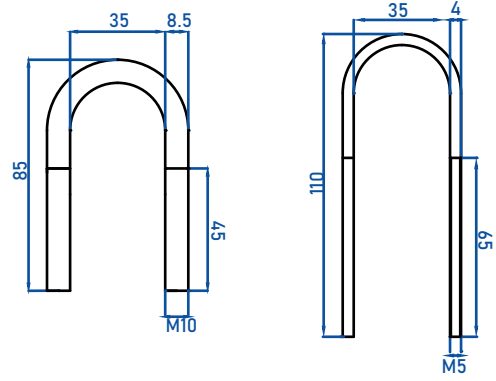

## SIEVE ASSEMBLY EQUIPMENT J - BOLT

|         |         |             |
|---------|---------|-------------|
| DME-028 | 200 PCS | M6 - 14 cm  |
|         | 200 PCS | M8 - 14 cm  |
|         | 100 PCS | M10 - 14 cm |
|         | 100 PCS | M12 - 14 cm |

|         |         |             |
|---------|---------|-------------|
| DME-029 | 100 PCS | M8 - 18 cm  |
|         | 100 PCS | M10 - 18 cm |
|         | 100 PCS | M12 - 18 cm |
|         | 100 PCS | M14 - 18 cm |
|         | 100 PCS | M16 - 18 cm |

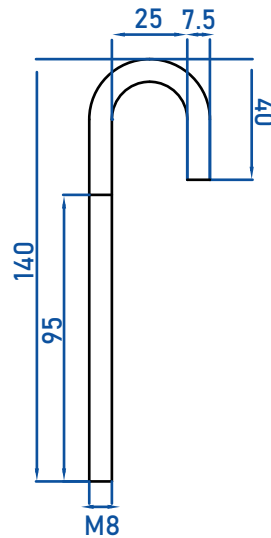

## ELEVATOR BUCKET FASTENER PRODUCT GROUP

|         |          |   |
|---------|----------|---|
| DKK-008 | 1000 PCS | M6 x 30 Bucket Fastener (Yellow Passivation)  |
| DKK-009 | 1000 PCS | M6 x 40 Bucket Fastener (Yellow Passivation)  |
| DKK-010 | 1000 PCS | M8 x 30 Bucket Fastener (Yellow Passivation)  |
| DKK-011 | 1000 PCS | M8 x 40 Bucket Fastener (Yellow Passivation)  |
| DKK-012 | 1000 PCS | M8 x 50 Bucket Fastener (Yellow Passivation)  |
| DKK-013 | 500 PCS  | M10 x 40 Bucket Fastener (Yellow Passivation) |
| DKK-014 | 500 PCS  | M10 x 50 Bucket Fastener (Yellow Passivation) |



## ELEVATOR STEEL BUCKET FASTENER PRODUCT GROUP

|         |          |  |
|---------|----------|--|
| DCK-015 | 1000 PCS | M8 x 30 Steel Bucket Fastener (Galvanized Coated)  |
| DCK-016 | 1000 PCS | M8 x 40 Steel Bucket Fastener (Galvanized Coated)  |
| DCK-017 | 500 PCS  | M10 x 40 Steel Bucket Fastener (Galvanized Coated) |
| DCK-018 | 500 PCS  | M10 x 50 Steel Bucket Fastener (Galvanized Coated) |



## ELEVATOR OVAL JACKSON FASTENER PRODUCT GROUP

|         |          |   |
|---------|----------|---|
| DJK-019 | 1000 PCS | M6 x 30 Steel Bucket Fastener (Yellow Passivation)  |
| DJK-020 | 1000 PCS | M8 x 30 Steel Bucket Fastener (Yellow Passivation)  |
| DJK-021 | 1000 PCS | M8 x 40 Steel Bucket Fastener (Yellow Passivation)  |
| DJK-022 | 1000 PCS | M8 x 50 Steel Bucket Fastener (Yellow Passivation)  |
| DJK-023 | 500 PCS  | M10 x 40 Steel Bucket Fastener (Yellow Passivation) |
| DJK-024 | 500 PCS  | M10 x 50 Steel Bucket Fastener (Yellow Passivation) |

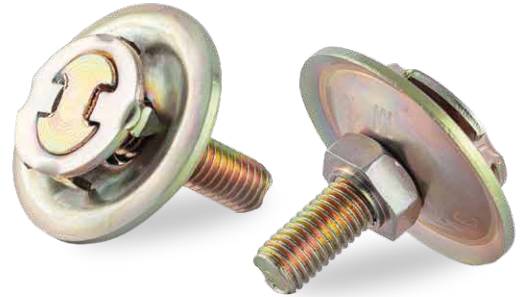

## SIEVE ASSEMBLY EQUIPMENT STRETCHING BOLT

|         |         |                                  |
|---------|---------|----------------------------------|
| DCG-029 | 100 PCS | M16 x 110 Camber Stretching Bolt |
| DCG-030 | 100 PCS | M16 x 130 Camber Stretching Bolt |
| DCG-031 | 100 PCS | M16 x 110 Hammer Stretching Bolt |
| DCG-032 | 100 PCS | M16 x 130 Hammer Stretching Bolt |
| DCG-033 | 50 PCS  | M18 x 150 Hammer Stretching Bolt |

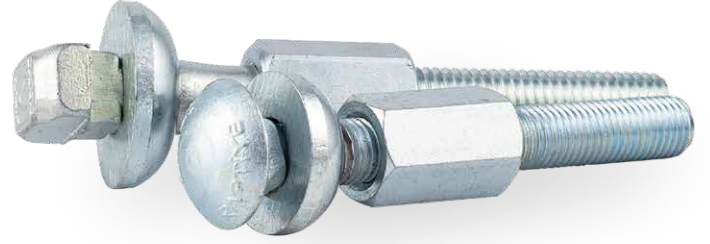

## CARRIAGE BOLT PRODUCT GROUP

|         |          |                        |
|---------|----------|------------------------|
| DYM-030 | 1000 PCS | M6 x 30 Carriage Bolt  |
| DYM-031 | 1000 PCS | M6 x 40 Carriage Bolt  |
| DYM-032 | 1000 PCS | M8 x 30 Carriage Bolt  |
| DYM-033 | 1000 PCS | M8 x 40 Carriage Bolt  |
| DYM-034 | 500 PCS  | M10 x 40 Carriage Bolt |
| DYM-035 | 500 PCS  | M10 x 50 Carriage Bolt |
| DYM-036 | 500 PCS  | M12 x 40 Carriage Bolt |
| DYM-037 | 500 PCS  | M12 x 50 Carriage Bolt |



## CONVEYOR BOLT PRODUCT GROUP

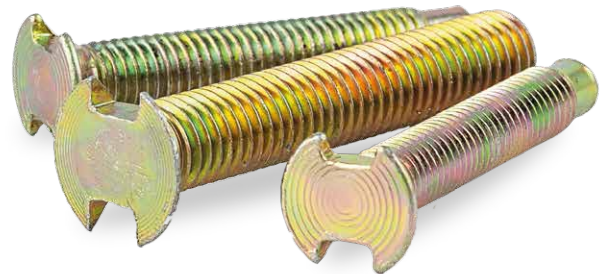

|         |          |  |
|---------|----------|--|
| DCK-016 | 1000 PCS | M6 x 30 Slotted Bolt (Yellow Passivation)  |
| DCK-017 | 500 PCS  | M8 x 30 Slotted Bolt (Yellow Passivation)  |
| DCK-018 | 500 PCS  | M8 x 40 Slotted Bolt (Yellow Passivation)  |
| DCK-019 | 500 PCS  | M8 x 50 Slotted Bolt (Yellow Passivation)  |
| DCK-020 | 500 PCS  | M10 x 40 Slotted Bolt (Yellow Passivation) |
| DCK-021 | 500 PCS  | M10 x 50 Slotted Bolt (Yellow Passivation) |
| DCK-022 | 200 PCS  | M10 x 60 Slotted Bolt (Yellow Passivation) |









## NUT PRODUCT GROUP

|         |   |  |
|---------|---|--|
| DIN 934 |  500 PCS | M5 Steel Nut White                     |
|         |  500 PCS | M6 Steel Nut White                     |
|         |  300 PCS | M8 Steel Nut White/Yellow Passivation  |
|         |  200 PCS | M10 Steel Nut White/Yellow Passivation |
|         |  200 PCS | M12 Steel Nut White                    |
|         |  100 PCS | M14 Steel Nut White                    |
|         |  100 PCS | M16 Steel Nut White                    |

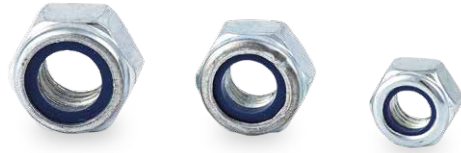

|         |   |              |
|---------|---|--------------|
| DIN 985 |  500 PCS   | M6 Lock Nut  |
|         |  300 PCS  | M8 Lock Nut  |
|         |  300 PCS | M10 Lock Nut |
|         |  200 PCS | M12 Lock Nut |



|         |   |                         |
|---------|---|-------------------------|
| DYM-038 |  100 PCS | M16 Stretching Bolt Nut |
| DYM-039 |  50 PCS  | M18 Stretching Bolt Nut |



|         |   |  |
|---------|---|--|
| DYM-040 |  200 PCS | M10 Slotted Round Nut (Yellow Passivation) |
| DYM-041 |  500 PCS | M8 Slotted Round Nut (Yellow Passivation)  |





## HINGED FASTENER

Hinged fasteners pass over the drums and take their shape while the conveyor system is in motion. It prevents the stretching of rubber bands, which is already a flexible material, and prevents them from breaking and ensures that the system continues to work as it should.

## BELT LACING

Belt Lacing fasteners, which are a relatively economical, sub-class of systems containing drums in areas such as agriculture and food, production, conveyor and transfer, packaging, create tension in one-piece bands and eliminate loosening.



## SIEVE ASSEMBLY EQUIPMENT

In chemical, food, underwater, yacht, ship industries, fire extinguishing lines, leather and machinery industry, construction industry, U Bolt bolts used for fixing pipelines to walls and mounting pipes to channels and J bolts used for tensioning sieve wires and mines; Stretching bolts for fixing the sieve in sand, gravel, coal mines, other crushing and screening plants are the main assembly equipment of these industries.

## BELT FASTENERS

Belt fasteners developed to carry heavy products and difficult materials have a superior holding power. The compression of the lower and upper plates and the combination of durable bolts provide faster action compared to vulcanization.



# The Master is also on flexada.com



www.flexada.com

info@flexada.com



flexadacom

0 (216) 394 36 36

A trademark of  
**DALGIÇ GLOBAL™**  
İÇ VE DIŞ TİCARET ANONİM ŞİRKETİ

0(216) 394 36 36  
0(216) 561 34 37  
0(312) 552 29 29

www.dalgicglobal.com.tr

info@dalgicglobal.com.tr

/dalgicglobal